



DRYWALL TOOLS

010755

FLYER'S

Forged aviation snip



- +** Cutting capacities :
 - 1.2 mm (16 ga ; 0.047") : sheet metal, galvanised, zinc.
 - 0.8 mm (20 ga ; 0.031") : stainless steel.
- Drop forged chromium molybdenum steel jaws.
- Powerful and long lasting handle spring.
- One hand automatic latch release.
- Fast cut with minimum effort of 42 mm.
- Finger guard.
- New SUPERPRO SERIE grip.

Gencod : 3476060001078 450 g



Gencod : 3476063107807 4885 g



010955

APOLLO

Forged aviation snip right cut



- +** Compound action shape snips.
- Cutting capacities :
 - 0.9 mm (19 ga ; 0.035") : stainless steel.
 - 1 mm (18 ga ; 0.039") : blue sheet steel.
 - 1.2 mm (16 ga ; 0.047") : galvanised sheet, zinc.
 - 1.5 mm (15 ga ; 0.059") : copper, brass, sheet metal.
 - 2 mm (12 ga ; 0.078") : PVC, aluminium.
 - 2.5 mm (10 ga ; 0.098") : polycarbonate.
- Cuts up to 35 mm at once.
- Finger guard.
- New SUPERPRO SERIE grip.

Gencod : 3476060001092 525 g



Gencod : 3476060010902 525 g



074555

PLURICOUF' ERGO

Multi-purpose pliers with angled blades



- +** Light and easy to handle.
- 42 mm stainless steel polished serrated blades.
- Unbreakable ergonomic arms and easy-to-close catch.
- Applications : home improvement, painting, gardening, textile industry, maintenance, construction, industry.
- Angled blades for an optimum comfort.

Gencod : 3476060007452 167 g



Gencod : 3476063745108 2000 g

073555

PLURICOUF' TOUT

Multi purpose pliers



Gencod : 3476060007353 168 g



- Up to 125 mm max. width and 60 mm max. height.
- Effortless clean cut without blur.
- Time saving.
- Noise free.
- No risk of fire because of the lack of sparks.
- Able to cut ceiling suspension system and metal corner beads.



060055

PROFIL

Section setting pliers for studs and tracks

«The Original»



PATENTED



- Max. capacity : 1 + 1 mm.
- New patented punch.
- 60 % easier to fasten.
- 30 % less effort.



350 mm

Gencod : 3476060006004 930 g



060155

PUNCHING BLADE FOR PROFIL



Gencod : 3476060006011 45 g



061055

PROFIL 2 RM

Section setting pliers for studs and tracks

«The Original»



PATENTED



- Special renovation.
- Max. capacity : 0,8 + 0,8 mm.
- For right and left setting.
- Articulated head.
- New patented punch.
- 60 % easier to fasten.
- 30 % less effort.



330 mm

Gencod : 3476060006103 700 g

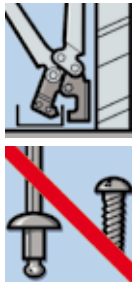

062055

MASTER PROFIL

One hand section setting pliers for studs and tracks

«The Original»

PATENTED



- One handed compound action.
- Max. capacity : 1 + 1 mm.
- Sprung handle.
- New patented punch.
- 60 % easier to fasten.
- 30 % less effort.



260 mm



062155

PUNCHING BLADE FOR MASTER PROFIL



Gencod : 3476060006219 17 g



062255

5 SPRINGS FOR MASTER PROFIL



Gencod : 3476060006226 31 g

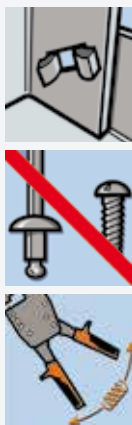

Gencod : 3476060006202 720 g

«The Original»

PATENTED



- For all type of studs and tracks.
- Max. capacity : 1 + 1 mm.
- Special renovation.
- For right and left setting.
- New patented punch.
- 60 % easier to fasten.
- 30 % less effort.

300 mm



Gencod : 3476060006196 760 g



O61855

PUNCHING BLADE FOR POWER PROFIL & ERGOTOP



Gencod : 3476060006189 10 g



O66855

ULTRA PROFIL

One hand section setting pliers for all type of studs and tracks, without any effort

PATENTED



- For all types of studs and tracks.
- One handed compound action to crimp studs and tracks without any effort, thanks to its 5 notch ratchet system.
- Max capacity : 1 + 1 mm.
- New patented punch.
- 60 % easier to fasten.
- 30 % less effort.



300 mm



Gencod : 3476060006684 825 g

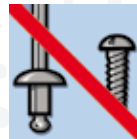

566855

PUNCHING BLADE FOR ULTRA PROFIL



Gencod : 3476060056689 34 g



160455

DUO PROFIL

Section setting pliers for back-to-back studs



PATENTED

330 mm



- Specially designed for back-to-back studs crimping.
- Recommended in case of ceiling above 2,50 m height.
- Regular stud-to-track crimping up to 70 mm width.
- Max.capacity : 1 + 1 mm.



260455

REPLACEABLE PUNCHING BLADE FOR DUO PROFIL



Gencod : 3476060026040 34 g



610000

COUNTER DISPLAY DUO PROFIL



x 3

Gencod : 3476066100003 4900 g

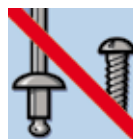

Gencod : 3476060016041 1490 g

161455

POWER PROFIL

Automatic section setting pliers for all type of studs and tracks, fits on drills



PATENTED

210 mm



- Can crimp all types of studs and tracks (even F530 studs for ceiling application).
- No crimping effort : let the drill do the job !
- Max. capacity : 1 + 1 mm.
- Fits all types of drills/screwdrivers (from 10,8 Volts).



O61855

PUNCHING BLADE FOR POWER PROFIL & ERGOTOP



Gencod : 3476060006189 10 g



Gencod : 3476060016140 1085 g

O64055

DUOPLAC

2 board carrier handles

115 mm

140 mm



- Ø 15 mm steel handles for board transport by 2 persons.
- Carries up to 2 boards.
- Soft rubber grips.
- Durable tool.
- Can be attached to belt.



Gencod : 3476060006400 1260 g

O64555

TRANSPLAC

Heavy duty board lifter



- Allows boards and sheets to be carried by just one person.
- New wide base for better panel seating.



Gencod : 3476060006455 1240 g

O69655

TRANSPLAC EASY

PE-HD board lever



- Allows board to be carried by one person only.
- Light and handy tool.
- Efficient and secure design for board holding.



Gencod : 3476060006967 315 g



O66055

FOOTPLAC

Board lever with steel stirrup



- Allows board to be lifted for accurate positioning thanks to its rocker system.
- Wide base prevents board damage while improving panel seating.
- Also ideal for unhinging doors.
- New extra wide loop suitable for all safety footwear.



Gencod : 3476060006608 925 g

O66555

BLOCPLAC II

Board holder

PLASTERBOARD HANDLING SOLUTIONS

DRYWALL TOOLS



- Allows to work alone thanks to the moveable block.
- Practical to lift and hold the board or insulation panel in position while screwing it to the metallic frame.
- Durable tool and easy to use.
- Offset handle.
- Beveled edge to avoid damaging the plasterboard.



Gencod : 3476060006653 1515 g



NEW



- Quick adjustment system.
- Ideal to carry easily terrace slabs (concrete or wood).
- Adjustable up to 625 mm width max. and 380 mm mini.

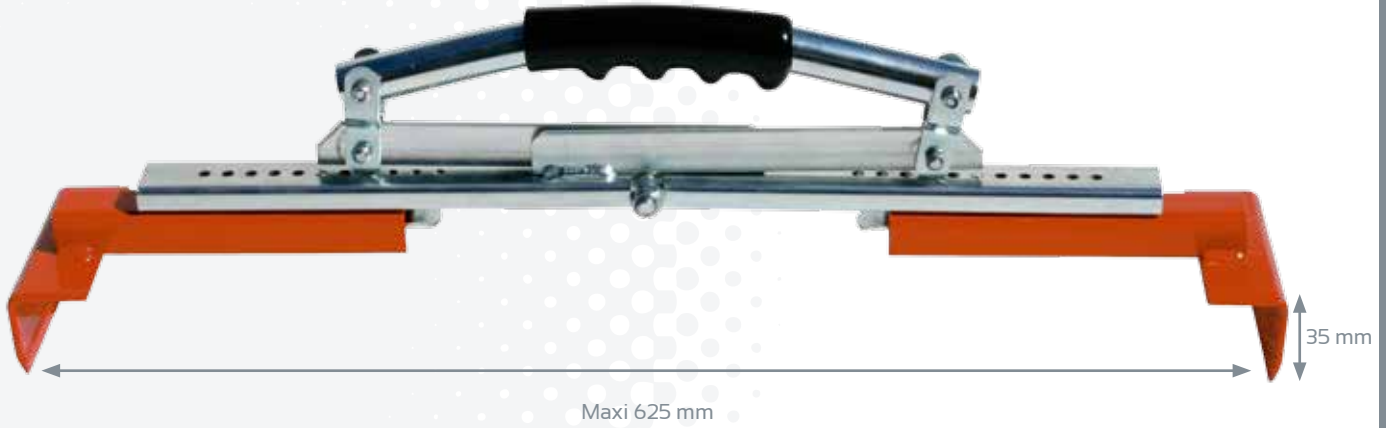

PLASTERBOARD HANDLING SOLUTIONS

DRYWALL TOOLS

O66155**160-290 CM MEDIUM QUICK SUPPORT**

- + Allows to maintain gypsum plates underneath ceilings or pitched roofs with fixation carefully.
- Extendable from 160 cm to 290 cm.
- 90° max. support : 60 kg.
- 65° max support : 20 kg.
- Safety lock.
- NEW articulated top and bottom pads (20 x 6 cm)
- Certified GS German norm.
- New handle.



Gencod : 3476060006615 2200 g

O66355**75-125 CM SMALL QUICK SUPPORT**

- + Allows to hold material in vehicle.
- Extendable from 75 cm to 125 cm.
- 90° max. support : 60 kg.
- 65° max support : 20 kg.
- Safety lock.
- Articulated top and bottom head.
- Certified GS German norm.



Gencod : 3476060006639 1370 g

O67855**210-390 CM GIANT QUICK SUPPORT**

- + Allows to maintain gypsum plates underneath ceilings or pitched roofs with fixation carefully.
- Extendable from 210 cm to 390 cm.
- 90° max. support : 60 kg.
- 65° max support : 20 kg.
- Safety lock.
- NEW articulated top and bottom pads (20 x 6 cm)
- Certified GS German norm.
- New handle.



Gencod : 3476060006783 3100 g

161055

PRESS PLAC PRO

Vertical support for plasterboard



- Minimum working required space for cutting, drilling or planing.
- Holding height : 32 cm.
- Lock screw for perfect holding.
- With carriage handle.



VIDEO

Gencod : 3476060016102  9350 g

163155

DRYWALL SCORING SQUARE



- Fast and neat straight cut.
- Max.62 cm.
- Perfect for scoring and cutting.
- Accept all type of utility knife.
- Double measurement unit : inch/mm.



VIDEO

Gencod : 3476060016317  615 g

160655

DRYWALL UTILITY KNIFE

With 25 mm snap-off blades

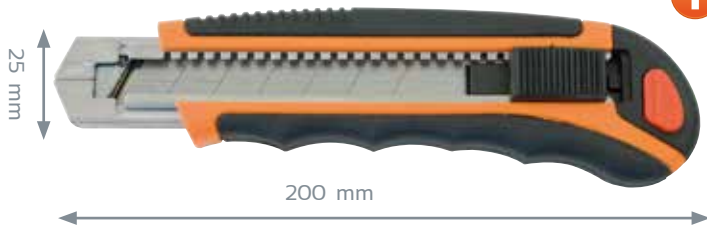

- Comes with 3 blades.
- Security locking blade action.
- Ergonomic and heavy duty design.



Gencod : 3476060016065  290 g

160600

COUNTER DISPLAY CUTTER
WITH 25 MM SNAP-OFF
BLADES

160755

10 SNAP-OFF BLADES, 25 MM

Gencod : 3476061606005  3420 gGencod : 3476060016072  188 g



064755

VARIO RAP

Plane for plasterboards & wood



- + 3 adjustable working positions.
- Replaceable rasps.



164755
FLAT RASP FOR VARIORAP



Gencod : 3476060016478 47 g

264755
ROUNDED RASP FOR VARIORAP



Gencod : 3476060026477 50 g



Gencod : 3476060006479 425 g

066755

EASY RAP

Mini plane for plasterboard



- + Replaceable rasp.
- Ergonomic design.

166755
FLAT RASP FOR EASYRAP



Gencod : 3476060016676 32 g



Gencod : 3476060006677 185 g

060655

FOLDABLE SAFETY KNIFE WITH HOLSTER

x 6

360655
COUNTER DISPLAY 6 PCS OF FOLDABLE SAFETY KNIFE



199255
10 LARGE CUTTING UTILITY BLADES



- + Retractable utility knife PRO for trapeze blades ref. 199255 and hook blades ref. 199655.
- 4 blades storage compartment.
- With belt holster.



Gencod : 3476060036063 2000 g

Gencod : 3476060019929 51 g

Gencod : 3476060006066 278 g



NEW



- Keyhole saw, useful for making cut-outs in plasterboard precast concrete, wood wall boards, etc.
- Triple bezel blade.
- Teeth on both sides for multidimensional cutting.
- Light and easy to handle.
- Ergonomic bi-material handle.



HOLSTER INCLUDED.

Gencod : 3476060006707 225 g

NEW



- Keyhole saw, useful for making cut-outs in plasterboard precast concrete, wood wall boards, etc.
- Triple bezel blade.
- Teeth on both sides for multidimensional cutting.
- Light and easy to handle.
- Ergonomic bi-material handle.



HOLSTER INCLUDED.

Gencod : 3476060006721 280 g

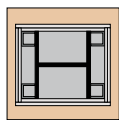
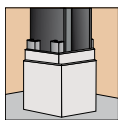

- Allows to cut up to 150 mm thick plaster strips.
- Stainless steel wheels.
- Up to 18 mm (0,708") thick with guide handle.
- Rail and metal framework fire protection (cribbed beam).
- Adjunction of allowance plaster strips in order to increase metal framework fire stability.
- Cutting strips to get neat edges.
- Repairing boards with damaged and dirty corners due to poor handling.
- Board height and width adjustment.



162955
SET OF 2 SPARE WHEELS FOR
PLAC&ROLL



Gencod : 3476060016294 18 g

Gencod : 3476060006295 1068 g



- For cutting plasterboard neatly and safety across its width (1200 mm).
- Cutting capacity = 600 mm wide and 25 mm thick.
- Avoids having to use a cutter.
- Replaceable stainless steel wheels (ref. 162955).
- Protection cap.
- Bi-material handle.



VIDEO

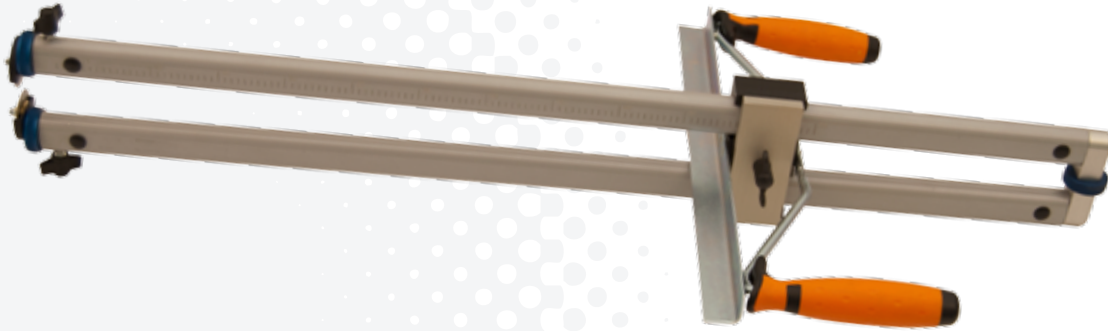

162955

SET OF 2 SPARE WHEELS FOR
PLAC&ROLL

O62855

CORNER FIX

Hand tool for fixing metal corner beads



- To crimp metal corner bead on outside corner drywall.
- Nylon tip.
- Ergonomic design.
- Replaceable jaws.
- Easy punching.



262855

NYLON TIP



Gencod : 3476060026286 50 g

162855

SET OF 2 JAWS FOR CORNER FIX



Gencod : 3476060016287 25 g

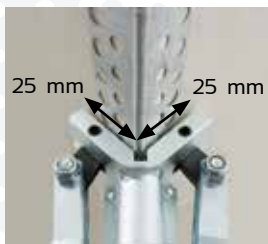

Gencod : 3476060006288 870 g

O69255

RAP-PLAC VERSATILE

Chamfering plane for plasterboard



- Chamfering angle : from 22 to 45°.
- Zinc plated steel body = durable tool.

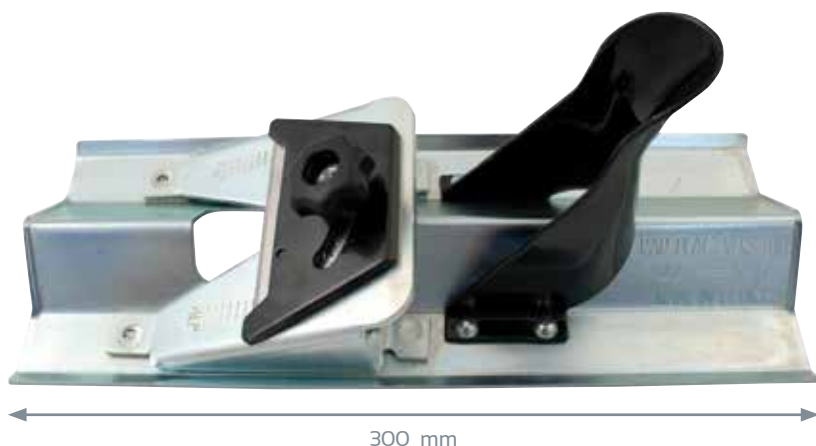

199255

10 LARGE CUTTING UTILITY BLADES



Gencod : 3476060019929 51 g



Gencod : 3476060006929 570 g

PLASTERBOARD CUTTING SOLUTIONS

DRYWALL TOOLS

O62755**30 M RED LINE ECO****Ultra light chalk line reel**

120 mm

- + Built-in filter system preventing excess chalk.
- Cord diameter : 1 mm.
- Capacity : 80 g.

Gencod : 3476060006271 120 g

O60555**30 M FAST LINE****Fast rewinding chalk line reel**

140 mm

**360555****COUNTER DISPLAY FAST LINE****X 8**

- + Rewinds 5 times faster.
- Built-in filter system preventing excess chalk.
- Cord diameter : 1 mm.
- Capacity : 100 g.

Gencod : 3476060036056 1300 g

Gencod : 3476060006059 165 g

O60755**30 M ALU LINE****Alu chalk line reel**

120 mm

**360755****COUNTER DISPLAY ALU LINE****X 8**

- + Built-in filter system preventing excess chalk.
- Cord diameter : 1 mm.
- Capacity : 80g.

Gencod : 347600036070 1390 g

Gencod : 3476060006073 177 g

260955**30 M MAX LINE****Chalk line reel with large handle (capacity : 400 g)**

255 mm

- + Chalk line reel with large handle for long distance marking.
- Special for bricklayer.
- Built-in filter system restricting excess chalk.
- Cord diameter : 2,5 mm.

Gencod : 3476060026095 600 g

O60955**50 M MAX LINE****Chalk line reel with large handle (capacity : 300 g)**

255 mm

- + Chalk line reel with large handle for long distance marking.
- Special for bricklayer.
- Built-in filter system restricting excess chalk.
- Cord diameter : 2,5 mm.

Gencod : 3476060006097 600 g

O63355**200 G BLUE MARKING CHALK**

Gencod : 3476060006332 230 g

O63255**400 G BLUE MARKING CHALK**

Gencod : 3476060006325 425 g

263655**1000 G OVERSEAS BLUE MARKING CHALK**

Gencod : 3476060026361 1070 g

O63155**1000 G BLUE MARKING CHALK**

Gencod : 3476060006318 1035 g

O65255**3500 G BLUE MARKING CHALK**

Gencod : 3476060006523 4250 g

162155

5 M X 25 MM TAPE MEASURE

NEW



- Slip and shock resistant built-in case.
- 25 mm nylon coating blade.
- Automatic locking and return.
- Class II accuracy (0,5 mm/m).
- Belt hook.



162100

COUNTER DISPLAY
5 M X 25 MM TAPE

X 6



Gencod : 3476061621008 1850 g

Gencod : 3476060016218 260 g

173055

ADJUSTABLE ANGLE SQUARE



- Adjustable angle.
- Can be folded to 0° in order to save space.
- 7 mm thickness aluminium = light and durable.

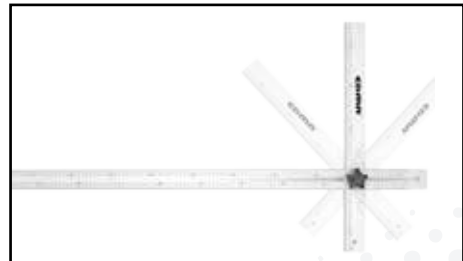
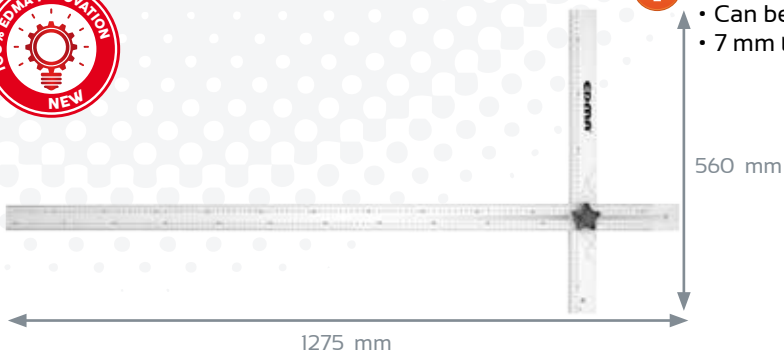

Gencod : 3476060017307 1425 g

173155

600 MM MASON SQUARE

NEW



- Steel square.

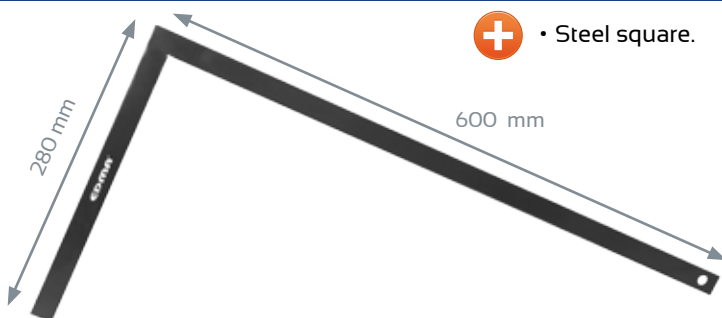

Gencod : 3476060017314 970 g

O20155

BABY-FIX BRICO

Expansion tool for all metal anchors



- +** • Ideal for DIY.
- Sprung handles.
- Double hinge.
- Good support surface : 100 x 20 mm.
- New anti finger pinching system.

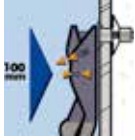
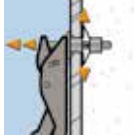
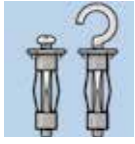
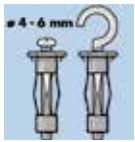

Gencod : 3476060002013 400 g

O21155

BABY-FIX JUNIOR

Expansion tool for all metal anchors



- +** • Ideal for serious DIY.
- Return spring and 2 component handles.
- Hardened steel arms and jaws.
- Double hinge.
- Good support surface : 100 x 20 mm.

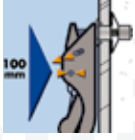
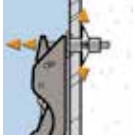
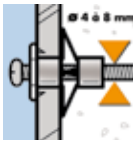

Gencod : 3476060002112 440 g

O20355

FIX

Professional expansion tool for all metal anchors



- +** • Direct setting along the line of the hole.
- Sprung handles.
- Can be used with minimum effort.

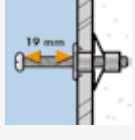
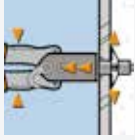
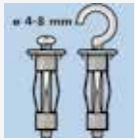
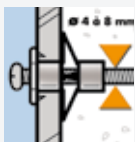

Gencod : 3476060002037 475 g

O21355

SUPER-FIX

Professional expansion tool for all metal anchors



245 mm



- Cranked head for setting in corners in one easy action.
- Sprung handles.
- Easy to use in confined spaces.

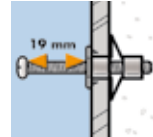
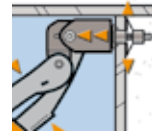
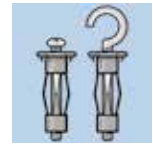
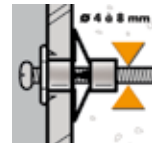

Gencod : 3476060002136 450 g

O23155

SUPRA-FIX

Professional expansion gun for all metal anchors



180 mm



- Easy to use in confined areas.
- Compact.
- Support surface : 20 x 20 mm.
- Improved stroke length : 20 mm.

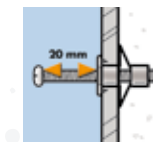
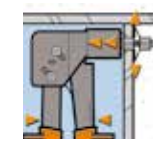

Gencod : 3476060002310 440 g

O23255

ULTRA-FIX

Professional expansion gun for all metal anchors



200 mm

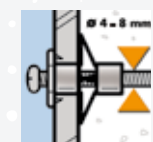
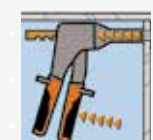
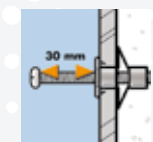

- 5 notch ratchet action.
- Specially designed for effortless use with anchors \varnothing 8 mm (5/16").
- Exceptional support surface of 30 mm.
- Easy handle release system.
- Ergonomic and anti-slip plastic handles for an optimum comfort.

PATENTED

Gencod : 3476060002327 545 g

O69055

CANALCUT

Precision insulation cutter



- For all types of insulation, such as : E.P.S, polyurethane, rock wool, glass wool, underfloor heating.
- 2 stainless steel blades for cuts of 35 mm (width) x 35 mm (depth) to insert sheaths of up to 32 mm diameter.
- 2 interchangeable blades
1/ Casing crossover version. Thermal bridges are easily avoided during cutting.
- 2/ 80 cm blade for curved shape removal. Scoring EPS/ plasterboard. Roofing water insulation grading. Cuts insulation material.
- Complies with RT 2012.

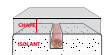
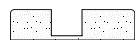
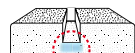

O69555

SPARE BLADES - TWIN 35 X 35 MM FOR CANALCUT



Gencod : 3476060006950 105 g



O68155

4 BLADES SET 40, 60, 80, 100 MM FOR CANALCUT



Gencod : 3476060006813 135 g



Gencod : 3476060006905 850 g

O66455

300 MM INSULATION CUTTER



- Easy use for all type of insulating material.
- 2 differents tooth shapes.
- Supplied with holster.
- Symmetrical double component handle.
- Can be used to cut without any effort rock wool, glass wool, wood wool or hemp insulating panels, flax, cellulose wadding panels, etc...



Gencod : 3476060006646 255 g

168055

420 MM INSULATION CUTTER



- Easy use for all type of insulating material.
- 2 differents tooth shapes.
- Supplied with holster.
- Symmetrical double component handle.
- Can be used to cut without any effort rock wool, glass wool, wood wool or hemp insulating panels, flax, cellulose wadding panels, etc...



Gencod : 3476060016805 286 g

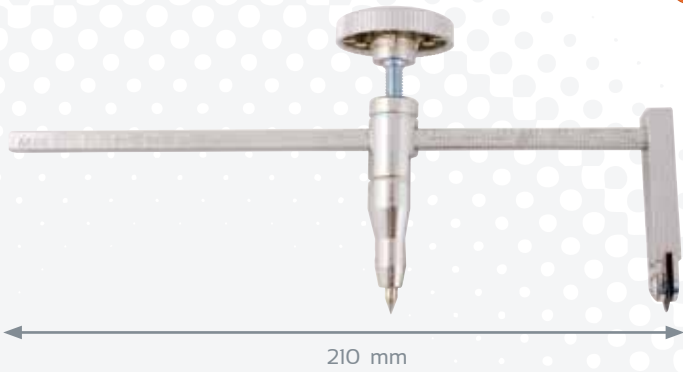

- Perfect for plasterboard notching.
- Max. diameter 400 mm.
- One hand use for easy pre cut.
- Use mallet or hammer to finalise the cut.



Gencod : 3476060006776  195 g



- Special for plasterboard.
- Can be used for wood, PVC and plasterboard.
- Depth cut : 32 mm.



Gencod : 3476060016225  295 g



- Special for plasterboard.
- Can be used for wood, PVC and plasterboard.
- Depth cut : 30 mm.



Gencod : 3476060016232  575 g



- Allows to complete trenches of 40 mm diameter in insulating materials behind gypsum walls without damaging them.
- Perfect to make your multimedia connections, switch and socket installations invisible.
- Saves time = no need to dig into the wall, to replaster it or to repaint it.
- STEP 1 : pierce 2 holes 40 mm diameter minimum into the gypsum wall, in vertical sens to each other 2,50 m distance maximum.
- STEP 2 : heat the hot ball with welding torch during 5 minutes.
- STEP 3 : introduce the hot ball into the hole above. That melts the polystyrene to make a channel connecting the 2 holes.

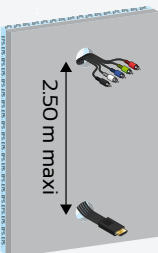

Gencod : 3476060026125  600 g

162655

HSS STEP DRILL

Use for precision drilling of sheet metal and plastic up to 30 mm



- Drilling Ø : from 4 to 30 mm in 2 mm increments.
- Max. drilling depth : 3 mm.
- Stud drilling (even back-to-back type) to insert sheaths.

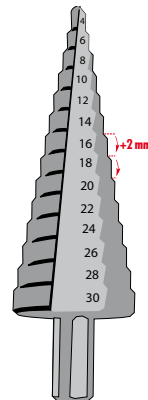

Gencod : 3476060016263 180 g

163955

DRILL BIT HOLDER

Philips No.2 drill bit for fixing PE-HD, plasterboard



- Drill bit with auto stop function for fast fixing without damaging the board.
- Ideal for fixing plasterboard.
- 12 PH2 bits included.
- Fits most types of drills/screwdrivers.



Gencod : 3476060016393 157 g

263955

6 PCS PH2 DRYWALL BIT



- Box of 6 PH2 bits, especially for plasterboard.
- Zinc coated stopper to screw perfectly in plasterboards without drilling through them.



Gencod : 3476060026392 95 g



- +** • SCREW FINDER finds hidden screws through plasterboards.
- Reuse your plasterboard and save money !
- To dismantle plasterboards safely without breaking them.
- SCREW FINDER is a pin with a spring and a magnet on its edge to find screw into metallic studs through plasterboards.
- When the magnet finds the screw, hit the SCREWFINDER with a hammer. Remove the plaster layer and you will find the screw to get off.
- The removed plasterboard can be reused.

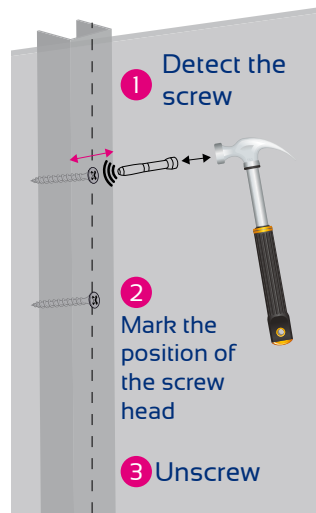

Gencod : 3476060016249 139 g



- +** • To detect studs and tracks made of steel, wood and electric cables behind plasterboard.
- Can detect through a 3/4 inch wall thickness.
- (Battery not included).



Steel

Wood

Electric cables



Gencod : 3476060026149 312 g

165155

25 L RUBBER BRICKLAYER' S HOD



- Mixture of rubber and polythylene combining the advantages of each of these materials : lightness, resistance and flexibility.
- Reinforced edges and sides.

Gencod : 3476060016515  1140 g

164655

12 L RUBBER BRICKLAYER' S HOD



- Mixture of rubber and polythylene combining the advantages of each of these materials : lightness, resistance and flexibility.
- Reinforced edges and sides.

Gencod : 3476060016461  502 g

164355

MULTI PURPOSE PAINT TOOL



- 5 tools in 1 : trim, scraper, paint roll cleaner, screwdriver for paint roll, taping knife.
- Steel blade hardened by treatment and protected by a varnish.
- Bi-material handle.

Gencod : 3476060016430  91 g

164555

7 CM PUTTY KNIFE



- Hardened steel blade and varnished 50 HRC.
- Large bevel.
- Brass ferrule.
- Wooden handle of French origin.

Gencod : 3476060016454  150 g

O66655

STAINLESS STEEL MUD PAN



- Ideal for repairs on plasterboard.
- Very strong.

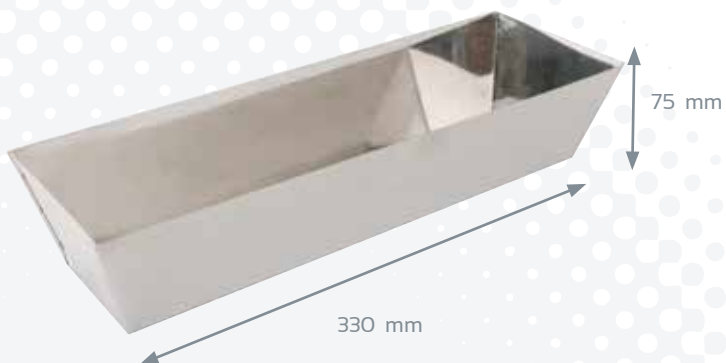

Gencod : 3476060006660 345 g

O66955

P.P. PLASTIC MUD PAN



- With galvanized steel blades to strike-off excess compound.

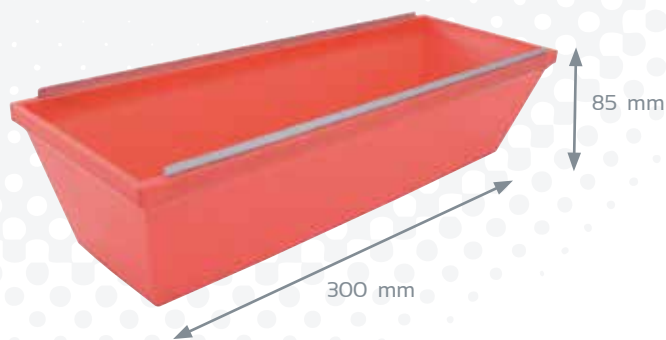

Gencod : 3476060006691 270 g

161855

MUD PAN HOLDER



- Device to hold mud pan on belt.
- Allows to reduce trip on working = time saving.
- Adjustable for all pan types.



Gencod : 3476060016188 325 g

O69855

DRYWALL TAPE HOLDER



- + Allows holding and dispensing drywall tape.
- Hangs on belt.
- Quick opening design makes changing tape easy.
- Made of steel and plated to prevent rust.



Gencod : 347606006981 370 g

261655

DRYWALL TAPER ROLLER TAPER II WITH TEK ROLL INCLUDED



- + Drywall taper with TEK ROLL accessory, for an easy apply of the tapes on walls, ceilings and inside corners.



161655

TEK ROLL - Accessory for drywall tapers



Gencod : 3476060016164 200 g



Gencod : 3476060026163 1750 g

266455

TAPE BUDDY

Joint tape machine

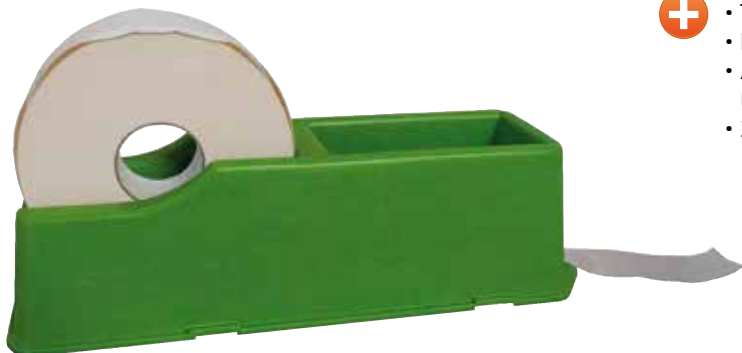

- + To glue your tapes directly without pre-seal paste !
- Easy to use.
- A thicker compound layer is deposited in the center of the tape for optimum gluing.
- 2 possible mud load thicknesses : thin or thick.



Gencod : 3476060026644 866 g

JOINT KNIVES



- For high drywall finishing performance.
- Ultra flexible polished stainless steel blade.
- With hardened NR2 Phillips bit.
- Quick lock and unlock of the NR2 Phillips bit in the handle.

169055 - 100 mm	Gencod : 3476060016904	142 g
169155 - 125 mm	Gencod : 3476060016911	153 g
169255 - 150 mm	Gencod : 3476060016928	155 g



JOINT KNIVES



- Stainless steel blade, hardened and mirror finish.
- Bi-material handle.
- Ergonomic design.

165255 - 20 mm	Gencod : 3476060016522	56 g
165355 - 40 mm	Gencod : 3476060016539	62 g
165455 - 60 mm	Gencod : 3476060016546	68 g
165555 - 80 mm	Gencod : 3476060016553	78 g
165655 - 100 mm	Gencod : 3476060016560	83 g
165755 - 120 mm	Gencod : 3476060016577	92 g
165855 - 150 mm	Gencod : 3476060016584	105 g





COATING KNIVES, CURVED SHAPE



- Special drywall knife.
- The curved shape of the blade is specially designed for good holding and taping of the compound.
- High resistance to solvents and shocks.

265155 - 100 mm	Gencod : 3476060026514	109 g
265255 - 120 mm	Gencod : 3476060026521	112 g
265355 - 140 mm	Gencod : 3476060026538	140 g
265455 - 160 mm	Gencod : 3476060026545	142 g
265555 - 180 mm	Gencod : 3476060026552	148 g
265655 - 200 mm	Gencod : 3476060026569	183 g
265755 - 220 mm	Gencod : 3476060026576	185 g
265855 - 240 mm	Gencod : 3476060026583	191 g



164055

RUBBER JOINT KNIFE

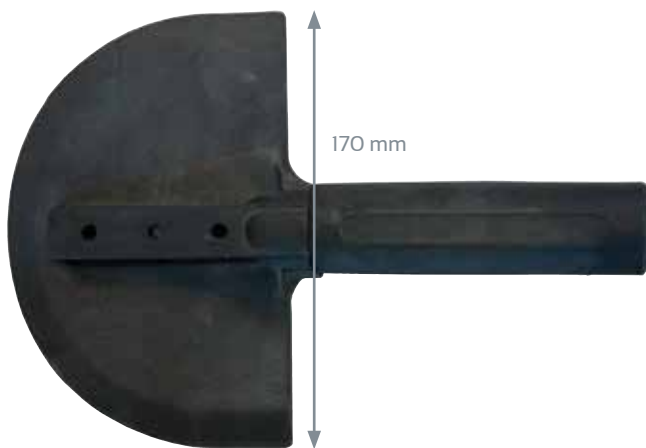

- To joint inner angles from 60° to 170° as well as angular area and round area.
- Rubber knife with nylon tip.
- Very light and easy to wash.
- Can be used with hand or a wooden handle.



Gencod : 3476060016409 145 g



- For all finishing coating.
- Ultra flexible stainless steel blade.
- Bi-material handle.



169355 - 200 mm

Gencod : 3476060016935 203 g

169455 - 250 mm

Gencod : 3476060016942 232 g

169555 - 300 mm

Gencod : 3476060016959 261 g

169655 - 350 mm

Gencod : 3476060016966 291 g



- Stainless steel blade mounted on rigid aluminium reinforcement.
- Bi-material ergonomic riveted handle.
- For application of compound on rough concrete substrate.

Gencod : 3476060016638 434 g



- Ideal for coating in inaccessible areas.
- Polished stainless steel blade.
- Bi-material handle.



Gencod : 3476060016706 119 g



- Ideal for coating in angles.
- Polished stainless steel blade.
- Bi-material handle.



Gencod : 3476060016799 127 g

